

Features

- Miniature construction
- Low-Noise Output
- 4.5 V to 6 V Operation
- Magnetically Optimized Package
- Linear output for circuit design flexibility
- Temperature range of -40 °C to 150 °C

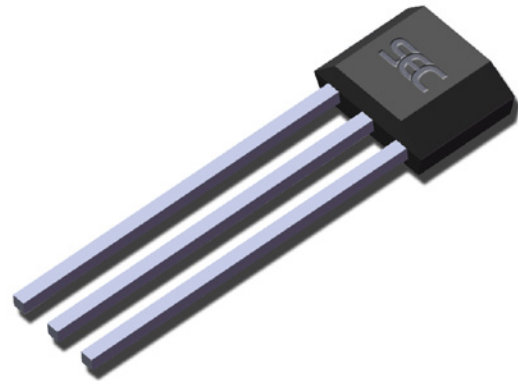

3 Pin SIP (suffix UA)

Description

SS3503 Linear Hall-effect sensor is small, versatile linear Hall-effect device that is operated by the magnetic field from a permanent magnet or an electromagnet. The linear sourcing output voltage is set by the supply voltage and varies in proportion to the strength of the magnetic field. The integrated circuitry features low noise out-

put, which makes it unnecessary to use external filtering. It also includes thin film resistors to provide increased temperature stability and accuracy. The linear Hall sensor has an operating temperature range of -40 °C to 150 °C appropriate for commercial, consumer and industrial environments.

Typical Applications

- Motor control
- Magnetic code reading
- Ferrous metal detector
- Current sensing
- Position sensing

Functional Block Diagram

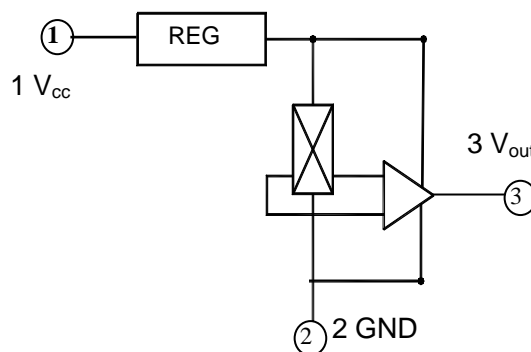

Pins Definition

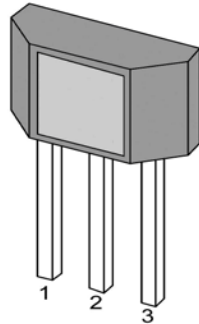

Name	No	Status	Description
Vdd	1	P	Power Supply
Gnd	2	P	IC Ground
Output	3	O	Output

Absolute Maximum Ratings

Parameter	Symbol	Value	Units
Supply Voltage (operating)	V_{CC}	8.0	V
Output Current	I_{OUT}	20	mA
Operating Temperature Range	T_A	-40~150	°C
Storage Temperature Rang	T_S	-65~150	°C

Electrical Characteristics

Operation Parameters $T_A = 25^{\circ}\text{C}$, $V_{CC} = 5.0\text{V}$

Parameter	Symbol	Test Conditions	Min	Typ	Max	Units
Operating voltage	V_{CC}	Operating	3.0		6.5	V
Supply current	I_{CC}	Average		4.2	8.0	mA
Output Current	I_{OUT}		1.0	1.5		mA
Response Time	T_{ack}			3		uS
Quiescent Output Voltage	V_o	$B = 0\text{G}$	2.25	2.5	2.75	V
Sensitivity	ΔV_{out}	$T_A = 25^{\circ}\text{C}$	2.0	2.5	3.0	mV/G
Min Output Voltage		$B = -1500\text{G}$		0.86		V
Max Output Voltage		$B = 1500\text{G}$		4.21		V

Performance Characteristics

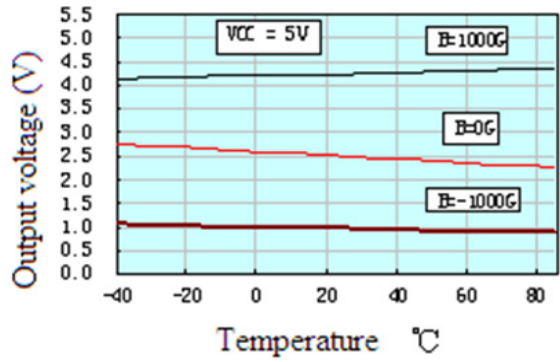
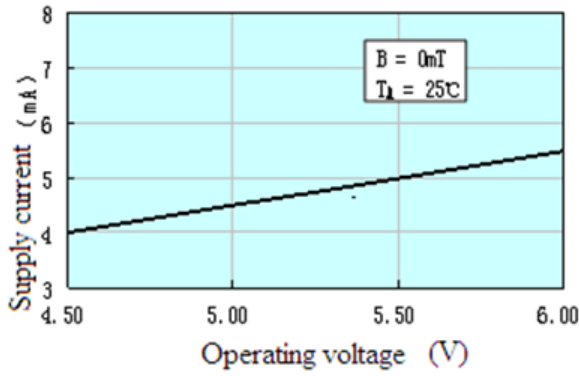
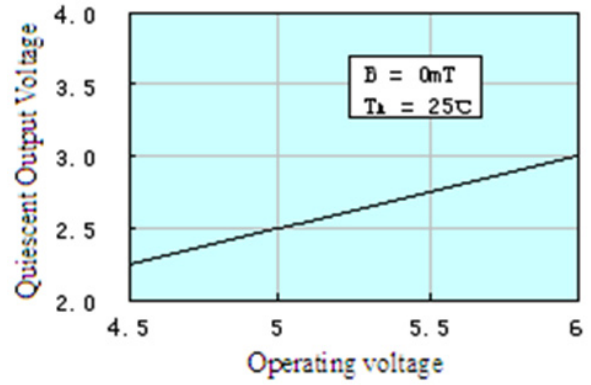
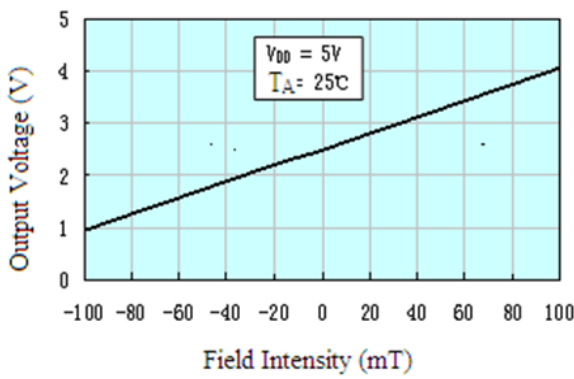

Package Information

Package UA, 3-Pin SIP:

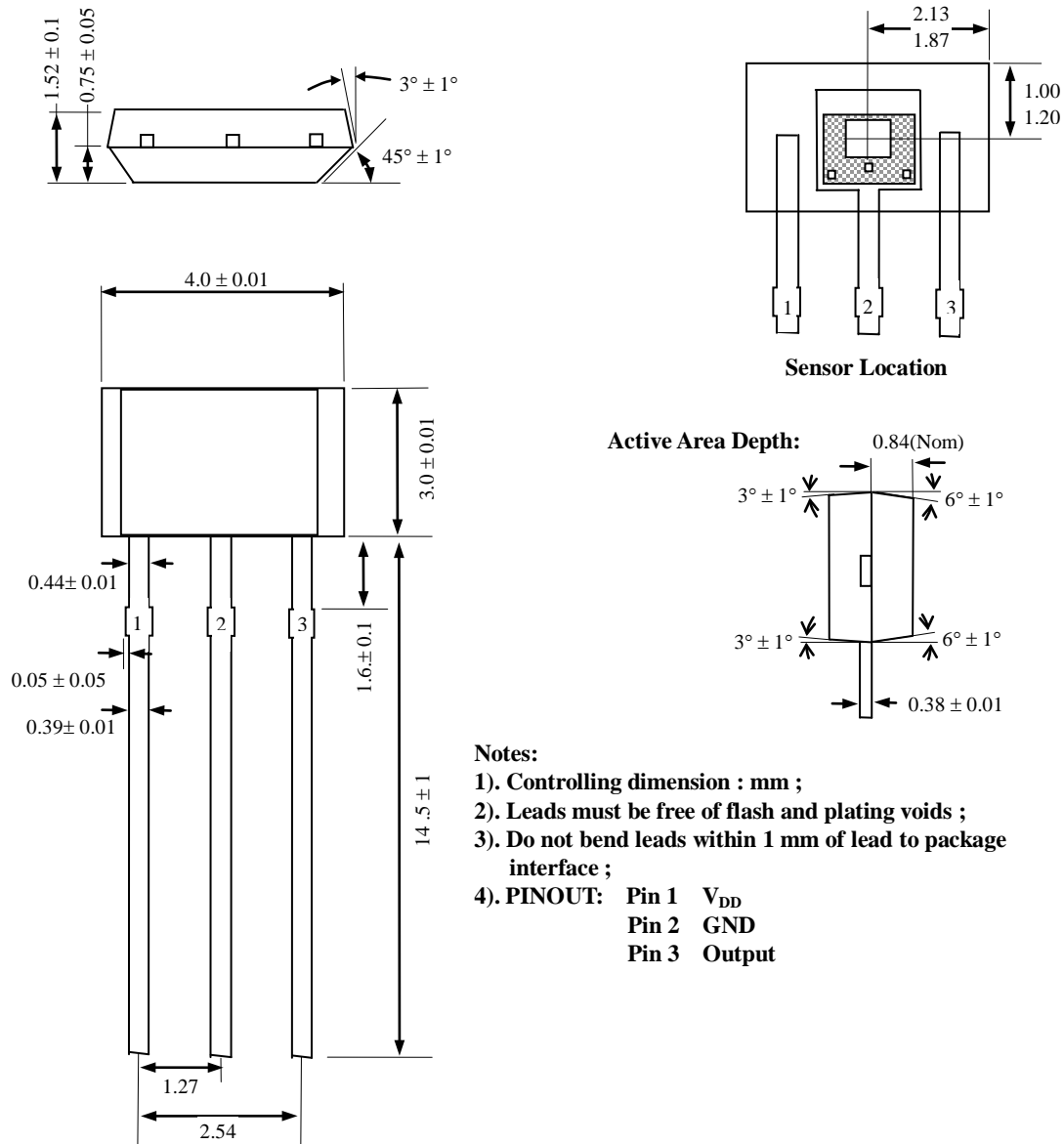

Notes:

- 1). Controlling dimension : mm ;
- 2). Leads must be free of flash and plating voids ;
- 3). Do not bend leads within 1 mm of lead to package interface ;
- 4). PINOUT: Pin 1 V_{DD}
Pin 2 GND
Pin 3 Output

Ordering Information

Part No.	Pb-free	Temperature Code	Package Code	Packing
SS3503EUA	YES	-40°C to 150°C	TO-92	Bulk, 1000 pieces/bag
SS3503KUA	YES	-40°C to 125°C	TO-92	Bulk, 1000 pieces/bag
SS3503LUA	YES	-40°C to 150°C	TO-92	Bulk, 1000 pieces/bag