

Packages

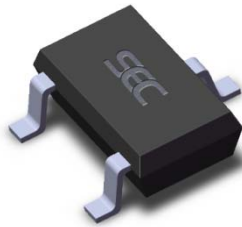

3 pin TSOT23 (suffix ST)



3 pin SIP (suffix UA)

Features and Benefits

- Wide operating voltage range from 3.5V to 24V
- High magnetic sensitivity
- CMOS technology
- Low current consumption
- Chopper-stabilized amplifier stage
- Output driver with internal pull-up resistor
- Superior temperature stability
- Insensitive to physical stress
- TSOT23 3L or flat SIP 3L both RoHS Compliant packages

Functional Block Diagram

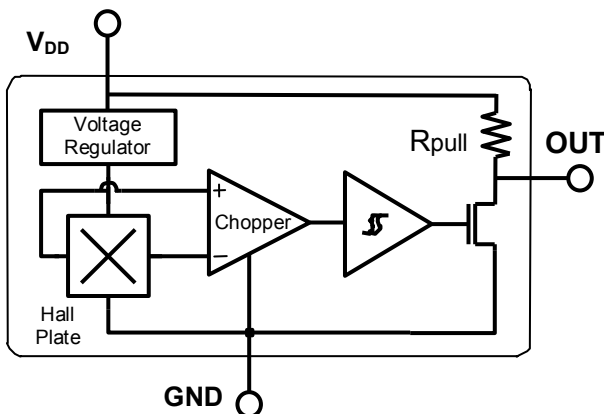

UA Package	SO Package
Pin 1 – V _{DD}	Pin 1 – V _{DD}
Pin 2 – GND	Pin 2 – OUT
Pin 3 – OUT	Pin 3 – GND

Application Examples

- Automotive, Consumer and Industrial
- Solid-state switch
- Brushless DC motor commutation
- Speed detection
- Angular position detection
- Linear position detection
- Proximity detection

General Description

The SS2509-R is a bipolar Hall effect sensor IC fabricated from mixed signal CMOS technology. The device integrates a voltage regulator, Hall sensor with dynamic offset cancellation system, Schmitt trigger and an output driver with internal pull-up resistor, all in a single package.

It incorporates advanced chopper stabilization techniques to provide accurate and stable magnetic switch points. There are many applications for this HED – Hall Electronic Device - in addition to those listed above. The design, specifications and performance have been optimized for commutation applications in 5V and 12V brushless DC motors.

Thanks to its wide operating voltage range and extended choice of temperature range, it is quite suitable for use in automotive, industrial and consumer applications.

The device is delivered in a Thin Small Outline Transistor (TSOT) for surface mount process or in a Plastic Single In Line (SIP 3L flat) for through-hole mount. Both 3-lead packages are RoHS compliant.

Glossary of Terms

MilliTesla (mT), Gauss	Units of magnetic flux density: 1mT = 10 Gauss
RoHS	Restriction of Hazardous Substances
TSOT	Thin Small Outline Transistor (TSOT package) - also referred with the package code "ST"
ESD	Electro-Static Discharge
BLDC	Brush-Less Direct-Current
Operating Point (B_{OP})	Magnetic flux density applied on the branded side of the package which turns the output driver ON ($V_{OUT} = V_{DSon}$)
Release Point (B_{RP})	Magnetic flux density applied on the branded side of the package which turns the output driver OFF ($V_{OUT} = high$)

Unique Features

Based on mixed signal CMOS technology, SS2509-R is a Hall-effect device with high magnetic sensitivity. This multi-purpose latch meets most of the application requirements.

The chopper-stabilized amplifier uses switched capacitor technique to suppress the offset generally observed with Hall sensors and amplifiers. The CMOS technology makes this advanced technique possible and contributes to smaller chip size and lower current consumption than bipolar technology. The small chip size is also an important factor to minimize the effect of physical stress. This combination results in more stable magnetic characteristics and enables faster and more precise design.

The wide operating voltage from 3.5V to 24V, low current consumption and large choice of operating temperature range according to "L", "K" and "E" specification make this device suitable for automotive, industrial and consumer applications.

Pin Definitions and Descriptions

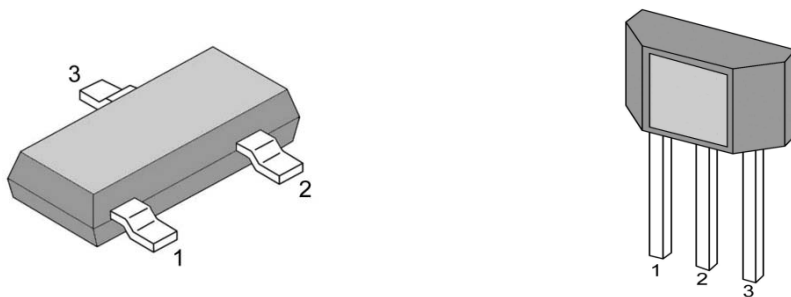

TSOT Pin №	SIP Pin №	Name	Type	Function
1	1	V_{DD}	Supply	Supply Voltage pin
2	3	OUT	Output	Open Drain Output pin
3	2	GND	Ground	Ground pin

Absolute Maximum Ratings

Parameter	Symbol	Value	Units
Supply Voltage	V _{DD}	28	V
Supply Current	I _{DD}	50	mA
Output Voltage	V _{OUT}	28	V
Output Current	I _{OUT}	50	mA
Storage Temperature Range	T _S	-50 to 150	°C
Maximum Junction Temperature	T _J	165	°C

Operating Temperature Range	Symbol	Value	Units
Temperature Suffix "E"	T _A	-40 to 85	°C
Temperature Suffix "L"	T _A	-40 to 150	°C

Exceeding the absolute maximum ratings may cause permanent damage. Exposure to absolute-maximum-rated conditions for extended periods may affect device reliability.

General Electrical Specifications

DC Operating Parameters T_A = 25°C, V_{DD} = 3.5V to 24V (unless otherwise specified)

Parameter	Symbol	Test Conditions	Min	Typ	Max	Units
Supply Voltage	V _{DD}	Operating	3.5		24	V
Supply Current	I _{DD}	B < B _{RP}			5	mA
Output Saturation Voltage	V _{DSon}	I _{OUT} = 20mA, B > B _{OP}			0.5	V
Output Leakage Current	I _{OFF}	B < B _{RP} V _{OUT} = 24V		1	10	μA
Output Rise Time	t _r	R _L = 1kΩ, C _L = 20pF		0.25		μs
Output Fall Time	t _f	R _L = 1kΩ, C _L = 20pF		0.25		μs
Internal pull-up resistor	R _{pu}	---	9	12	15	kΩ
Maximum Switching Frequency	F _{SW}	---		10		KHz
Package Thermal Resistance	R _{TH}	Single layer (1S) Jeduc board		301		°C/W

Note: The output of SS2509-R will be switched after the supply voltage is over 2.2V, but the magnetic characteristics won't be normal until the supply is over 3.5V.

Magnetic Specifications

DC Operating Parameters V_{DD} = 3.5 to 24V (unless otherwise specified)

Package	Parameter	Symbol	Test Conditions	Min	Typ	Max	Units
UA	Operating Point	B _{OP}	Ta=25°C V _{dd} =5V DC	-40	-18	-5	G
	Release Point	B _{RP}		5	18	40	G
	Hysteresis	B _{HYST}		25	35	50	G
ST	Operating Point	B _{OP}	Ta=25°C V _{dd} =5V DC	5	18	40	G
	Release Point	B _{RP}		-40	-18	-5	G
	Hysteresis	B _{HYST}		25	35	50	G

Output Behavior versus Magnetic Pole

DC Operating Parameters TA = -40°C to 150°C, V_{DD} = 3.5 to 24V (unless otherwise specified)

Test Conditions (UA)	Test Conditions (ST)	OUT
B > B _{RP}	B < B _{RP}	High
B < B _{OP}	B > B _{OP}	Low

The TSOT-23 device is reversed from the UA package. The TSOT-23 output transistor will be turned on (drops low) in the presence of a sufficiently strong South pole magnetic field applied to the marked face and turned off (hoists high) in the presence of a sufficiently strong North pole magnetic field.

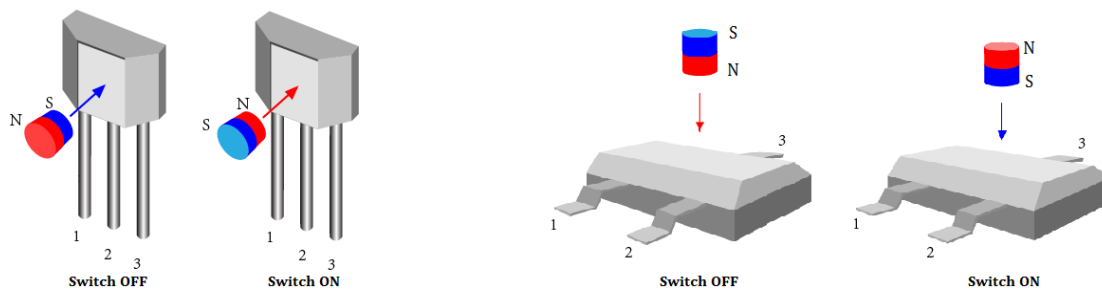

Detailed General Description

The SS2509-R exhibits latch magnetic switching characteristics. Therefore, it requires both south and north poles to operate properly.

In the case of UA package, the OUT pin of these devices switches low (turns on) when a magnetic field perpendicular to the Hall sensor reduced below the operate point threshold, B_{OP}. After turn-on, the output voltage is V_{DSon}. Note that the device latches, that is, a north pole of sufficient strength towards the branded surface of the device turns the device on. The device remains on if the south pole is removed (B→0). This latching property defines the device as a magnetic memory.

When the magnetic field exceeds the release point, B_{RP}, the OUT pin turns off (goes high). The difference in the magnetic operating and release points is the hysteresis, B_{HYST}, of the device. This built-in hysteresis prevents output oscillation near the switching point, and allows clean switching of the output even in the presence of external

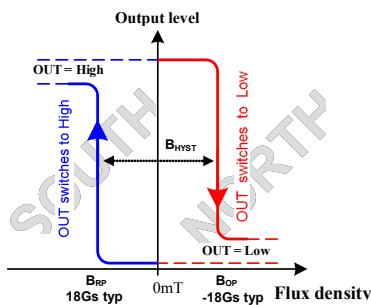

UA package - Latch characteristic

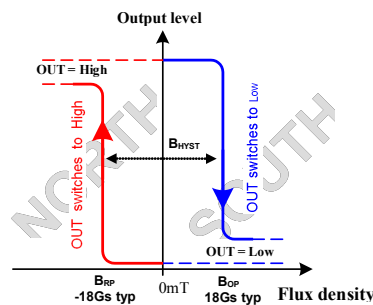

ST package - Latch characteristic

mechanical vibration and electrical noise.

The device behaves as a latch with symmetric operating and release switching points ($|B_{OP}|=B_{RP}$). This means

magnetic fields with equivalent strength and opposite direction drive the output high and low.

Powering-on the device in the hysteresis region (higher than B_{OP} and less than B_{RP}) allows an indeterminate output state. The correct state is attained after the first excursion beyond B_{OP} or B_{RP} .

The TSOT-23 device is reversed from the UA package. The TSOT-23 output transistor will be latched on in the presence of a sufficiently strong South pole magnetic field applied to the marked face.

Application Information

It is strongly recommended that an external bypass capacitor be connected (in close proximity to the Hall sensor) between the supply (V_{DD} Pin) and ground (GND Pin) of the device to reduce both external noise and noise generated by the chopper stabilization technique. As is shown in the two figures in next page, a $0.1\mu\text{F}$ capacitor is typical.

For reverse voltage protection, it is recommended to connect a resistor or a diode in series with the V_{DD} pin. When using a resistor, three points are important:

- the resistor has to limit the reverse current to 50mA maximum ($V_{CC} / R1 \leq 50\text{mA}$)
- the resulting device supply voltage V_{DD} has to be higher than V_{DD} min ($V_{DD} = V_{CC} - R1 \cdot I_{DD}$)
- the resistor has to withstand the power dissipated in reverse voltage condition ($P_D = V_{CC}^2 / R1$)

When using a diode, a reverse current cannot flow and the voltage drop is almost constant ($\approx 0.7\text{V}$).

Therefore, a $100\Omega/0.25\text{W}$ resistor for 5V application and a diode for higher supply voltage are recommended. Both solutions provide the required reverse voltage protection.

When a weak power supply is used or when the device is intended to be used in noisy environment, it is recommended that the second following figure is used.

The low-pass filter formed by R1 and C1 and the Zener diode Z1 bypass the disturbances or voltage spikes occurring on the device supply voltage V_{DD} . The diode D1 provides additional reverse voltage protection.

Typical Three-Wire Application Circuit

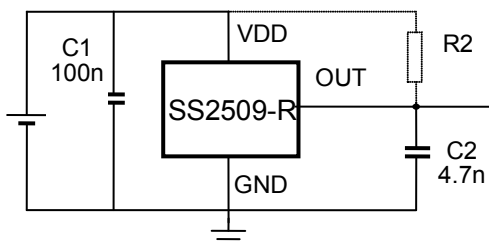

Automotive and Severe Environment Protection Circuit

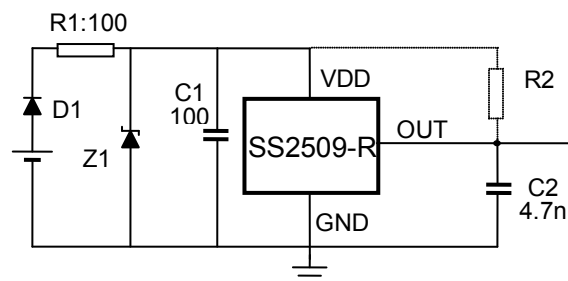

The SS2509-R have been optimized for commutation applications in 5V and 12V brushless DC motors. The following figure is the typical application circuit for 3 phase brushless DC motors.

Package Information

Package UA, 3-Pin SIP:

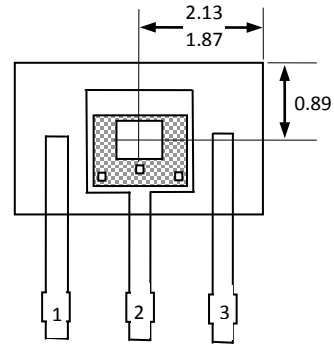
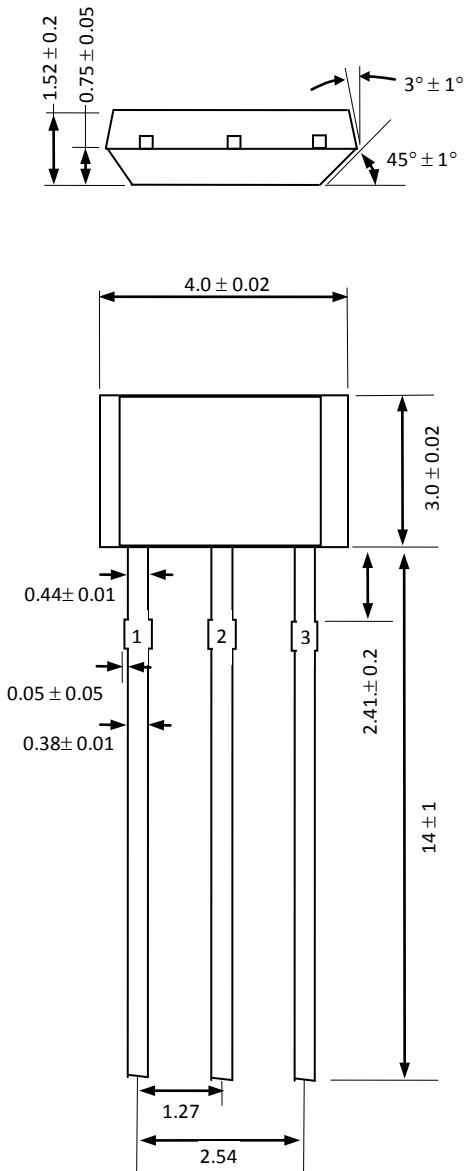

Sensor Location

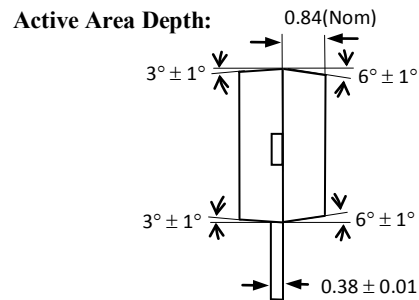

Notes:

- 1). Controlling dimension : mm ;
- 2). Leads must be free of flash and plating voids ;
- 3). Do not bend leads within 1 mm of lead to package interface ;
- 4). PINOUT: Pin 1 V_{DD}
Pin 2 GND
Pin 3 Output

Package ST, 3-Pin TSOT-23:

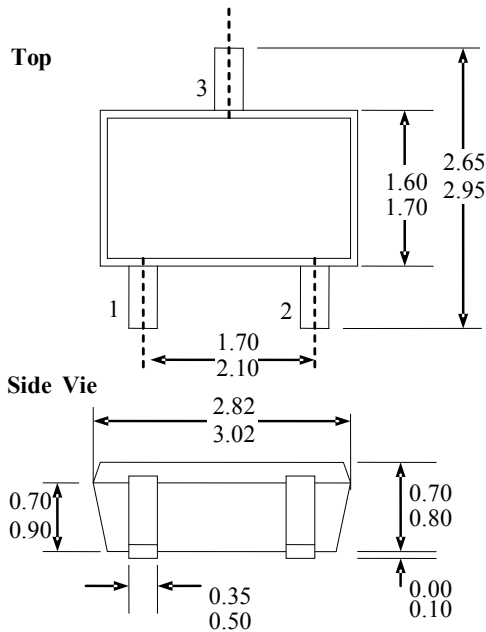

Notes

- 1). PINOUT: Pin 1 V_{DD}
Pin 2 Output
Pin 3 GND
- 2). All dimensions are in millimeters;

End View

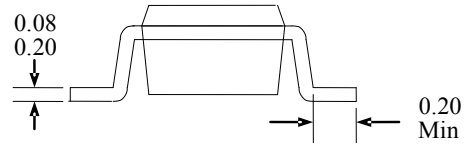

TSOT-23 Package Hall Location:

Bottom View of TSOT-23 Package

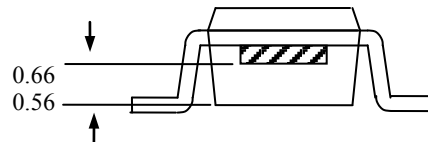
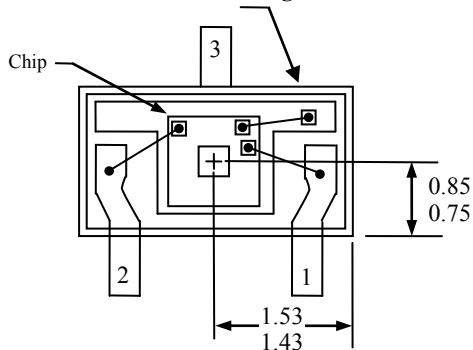

Ordering Information

Part No.	Pb-free	Temperature Code	Package Code	Packing
SS2509-RETT	YES	-40°C to 85°C	TSOT-23	7-in. reel, 3000 pieces/reel
SS2509-REUA	YES	-40°C to 85°C	TO-92	Bulk, 1000 pieces/bag
SS2509-RKSTT	YES	-40°C to 125°C	TSOT-23	7-in. reel, 3000 pieces/reel
SS2509-RKUA	YES	-40°C to 125°C	TO-92	Bulk, 1000 pieces/bag
SS2509-RLSTT	YES	-40°C to 150°C	TSOT-23	7-in. reel, 3000 pieces/reel
SS2509-RLUA	YES	-40°C to 150°C	TO-92	Bulk, 1000 pieces/bag