

Packages

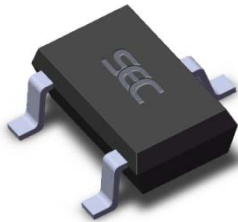

3 pin SOT23 (suffix SO)

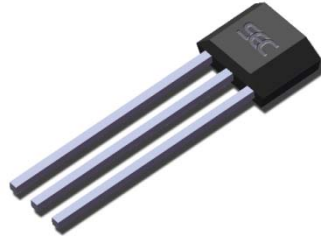

3 pin SIP (suffix UA)

Features and Benefits

- Solid-State Reliability much better than reed Switch
- Omnipolar, output switches with absolute value of North or South pole from magnet
- Operation from 2.5V to 5.5V
- High sensitivity for direct reed switch replacement applications

Functional Block Diagram

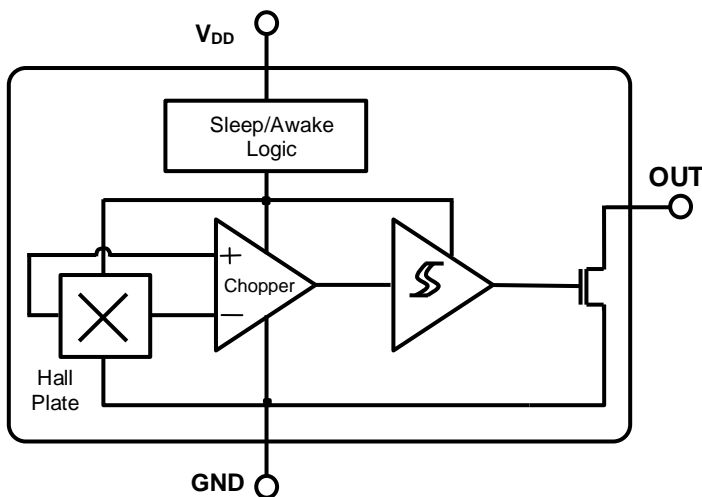

Application Examples

- Solid state switch
- Speed detection
- Interrupter
- Magnet proximity sensor for reed switch replacement

General Description:

The SS249 Omnipolar Hall effect sensor IC is fabricated from mixed signal CMOS technology .It incorporates advanced chopper-stabilization techniques to provide accurate and stable magnetic switch points.

The output transistor of the SS249 will be latched on (BOP) in the presence of a sufficiently strong South or North magnetic field facing the marked side of the package. The output will be latched off (BRP) in the absence of a magnetic field.

Typical Application Circuit

Typical Three-Wire Application Circuit

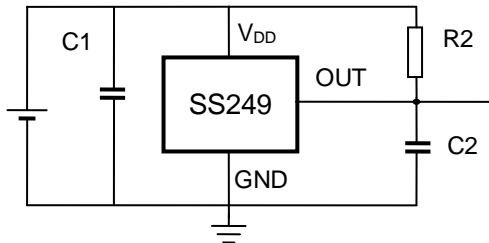

Automotive and Severe Environment Protection Circuit

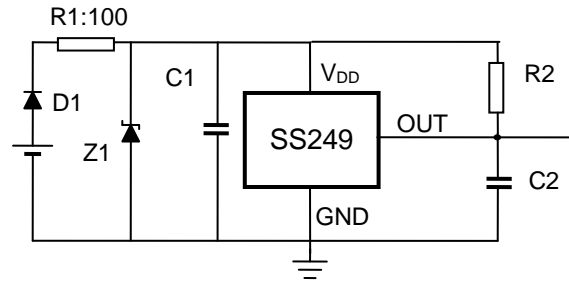

SEC's pole-independent sensing technique allows for operation with either a north pole or south pole magnet orientation, enhancing the manufacturability of the device. The state-of-the-art technology provides the same output polarity for either pole face.

It is strongly recommended that an external bypass be connected (in close proximity to the Hall sensor) between the supply and ground of the device to reduce both external noise and noise generated by the chop-per-stabilization technique. This is especially true due to the relatively high impedance of battery supplies.

Internal Timing Circuit

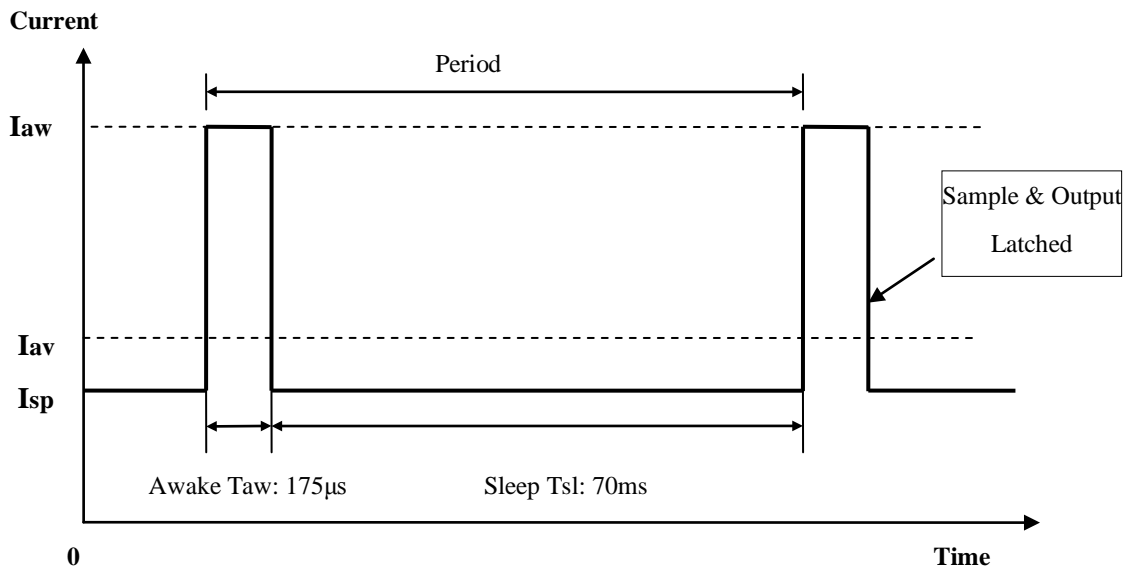

Pin Definitions and Descriptions

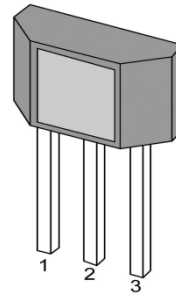
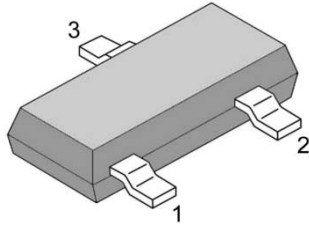

SOT Pin №	SIP Pin №	Name	Type	Function
1	1	V _{DD}	Supply	Supply Voltage pin
2	3	OUT	Output	Open Drain Output pin
3	2	GND	Ground	Ground pin

Absolute Maximum Ratings

Parameter	Symbol	Value	Units
Supply Voltage (operating)	V _{DD}	6	V
Supply Current	I _{DD}	5	mA
Output Voltage	V _{OUT}	6	V
Output Current	I _{OUT}	5	mA
Operating Temperature Range	T _A	-40 to 85	°C
Storage Temperature Range	T _S	-50 to 150	°C
ESD Sensitivity	-	4000	V

Exceeding the absolute maximum ratings may cause permanent damage. Exposure to absolute-maximum-rated conditions for extended periods may affect device reliability.

DC Electrical Characteristics

DC Operating Parameters: T_A = 25°C.

Parameter	Symbol	Test Conditions	Min	Typ	Max	Units
Operating Voltage	V _{DD}	Operating	2.5	3	5.5	V
Supply Current	I _{DD}	Average		5		μA
Output Current	I _{OUT}				1.0	mA
Saturation Voltage	V _{SAT}	I _{OUT} = 1mA			0.4	V
Awake mode time	T _{AW}	Operating		175		μS
Sleep mode time	T _{SL}	Operating			70	mS

ESD Protection

Human Body Model (HBM) tests according to: Mil. Std. 883F method 3015.7

Parameter	Symbol	Limit Values		Unit	Notes
		Min	Max		
ESD Voltage	V _{ESD}		±4	kV	

Magnetic Characteristics

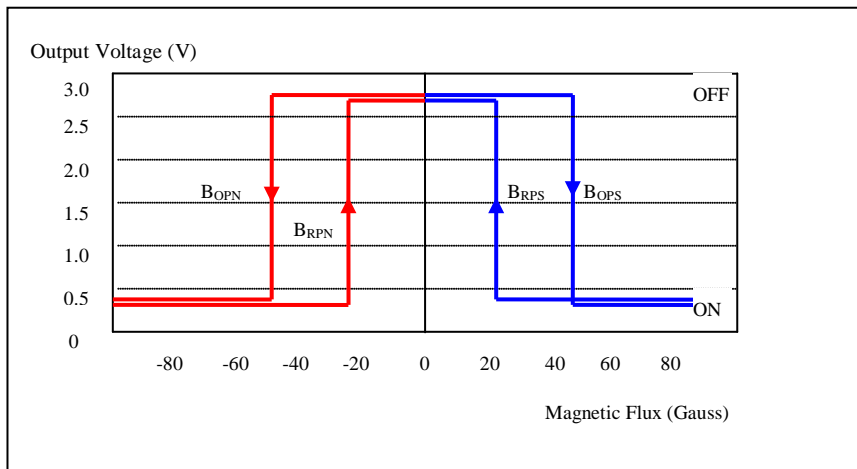

Operating Parameters: $T_A = 25^\circ\text{C}$, $V_{DD} = 2.75V_{DC}$

Parameter	Symbol	Min	Type	Max	Units
Operating Point	B _{OP}	-	+/-35	+/-60	Gs
Release Point	B _{RP}	+/-5	+/-21	-	Gs
Hysteresis	B _{HYST}	-	14	-	Gs

Performance Characteristics

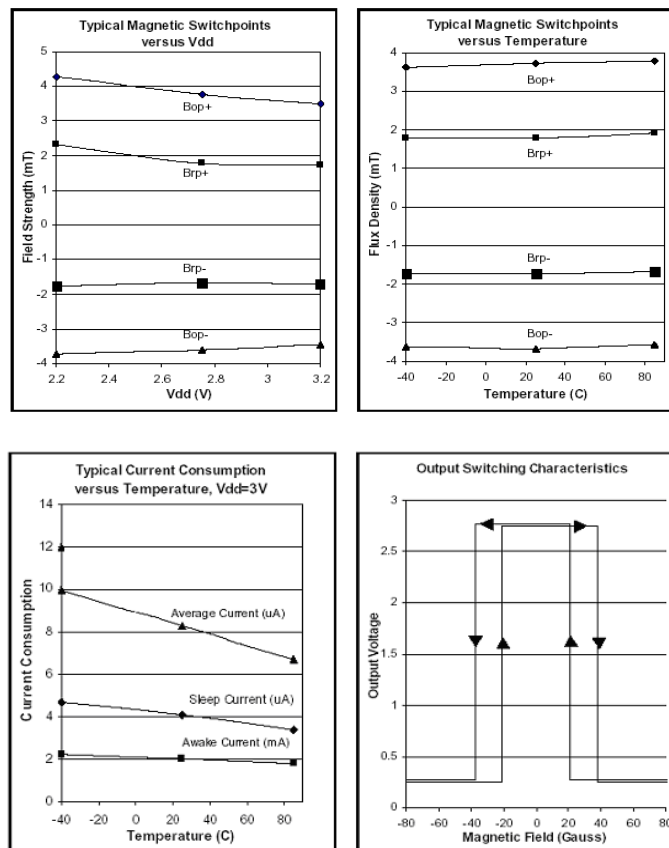

Unique Features

CMOS Hall IC Technology

The chopper stabilized amplifier uses switched capacitor techniques to eliminate the amplifier offset voltage, which, in bipolar devices, is a major source of temperature sensitive drift. CMOS makes this advanced technique possible. The CMOS chip is also much smaller than a bipolar chip, allowing very sophisticated circuitry to be placed in less space. The small chip size also contributes to lower physical stress and less power consumption.

Installation Comments

Consider temperature coefficients of Hall IC and magnetic, as well as air gap and life time variations. Observe temperature limits during wave soldering. Typical IR solder-reflow profile:

- No Rapid Heating and Cooling.
- Recommended Preheating for max. 2minutes at 150°C
- Recommended Reflowing for max. 5seconds at 240°C

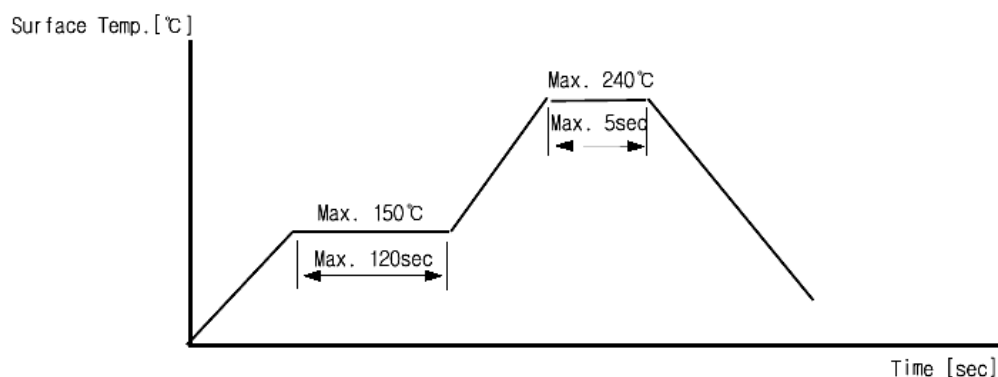

ESD Precautions

Electronic semiconductor products are sensitive to Electro Static Discharge (ESD).

Always observe Electro Static Discharge control procedures whenever handling semiconductor products.

Package Information

Package UA, 3-Pin SIP:

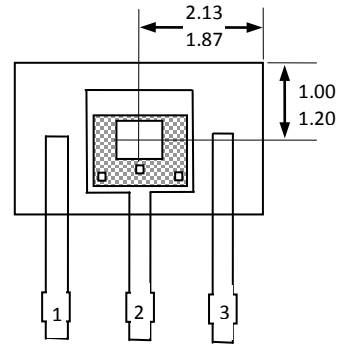
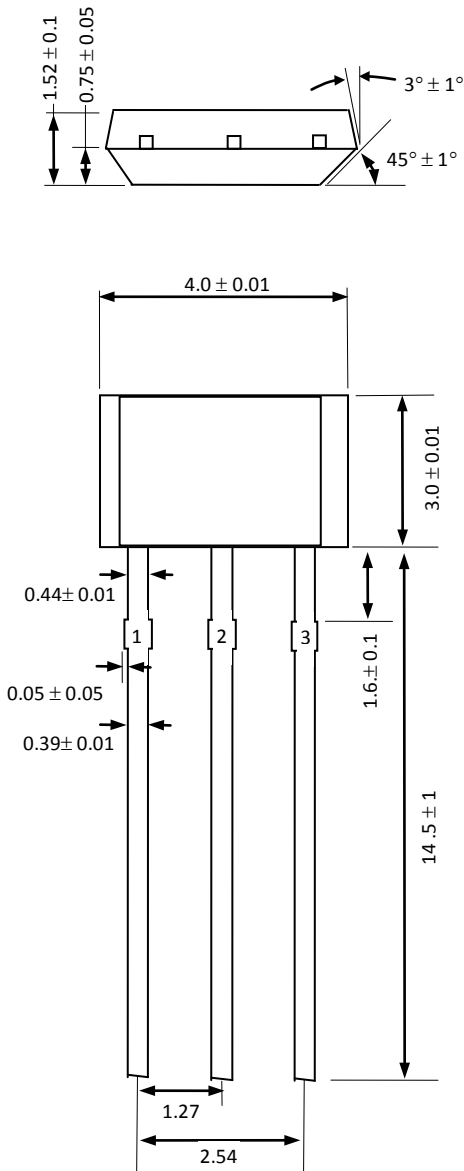

Sensor Location

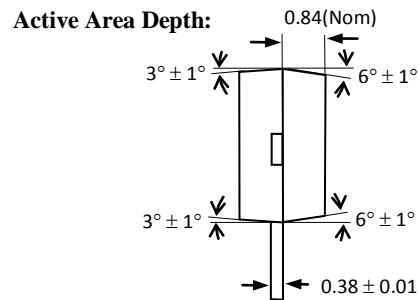

Notes:

- 1). Controlling dimension : mm ;
- 2). Leads must be free of flash and plating voids ;
- 3). Do not bend leads within 1 mm of lead to package interface ;
- 4). PINOUT: Pin 1 V_{DD}
Pin 2 GND
Pin 3 Output

Package SO, 3-Pin SOT-23:

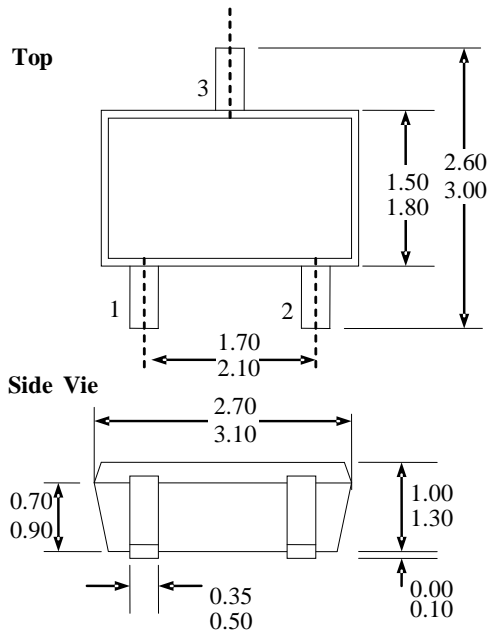

Notes

- 1). PINOUT: Pin 1 V_{DD}
Pin 2 Output
Pin 3 GND
- 2). All dimensions are in millimeters;

End View

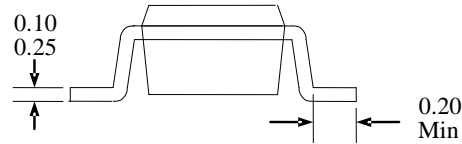

SOT-23 Package Hall Location:

Bottom View of SOT-23 Package

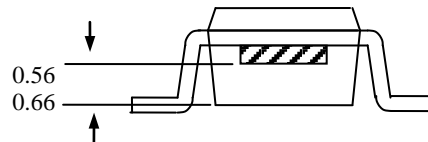
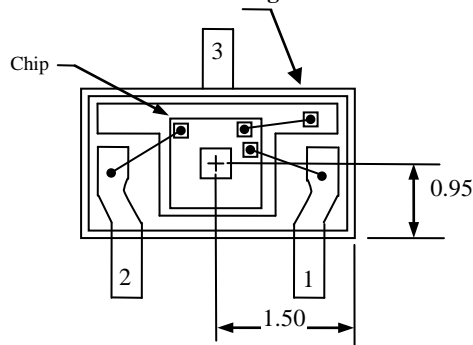

Ordering Information

Part No.	Pb-free	Temperature Code	Package Code	Packing
SS249ESOT	YES	-40°C to 85°C	SOT-23	7-in. reel, 3000 pieces/reel
SS249EUA	YES	-40°C to 85°C	TO-92	Bulk, 1000 pieces/bag
SS249KSOT	YES	-40°C to 125°C	SOT-23	7-in. reel, 3000 pieces/reel
SS249KUA	YES	-40°C to 125°C	TO-92	Bulk, 1000 pieces/bag
SS249LSOT	YES	-40°C to 150°C	SOT-23	7-in. reel, 3000 pieces/reel
SS249LUA	YES	-40°C to 150°C	TO-92	Bulk, 1000 pieces/bag